

Datasheet

Touch Pure CO2 Tree

Part No: 100517, 100518



About the product

The Loxone Touch Pure CO2 Tree features five touch points on a glass surface to control the most important functions of a room. When a button is touched, an acoustic click confirms the action. An integrated sensor measures temperature, relative humidity and CO2 value. An orientation light makes it possible to locate the device in the dark.

Technical Data

Power supply	6 ... 30VDC
Power consumption	typ. 0.05W, max. 0.1W
Power loss	max. 0.1W
Interface	Loxone Tree: connection with Miniserver / Tree Extension
Touch points	5 touch points, capacitive touch detection
Click feedback	Yes
Orientation light	Yes
Temperature detection range	-40 ... 125°C +/- 0.5°C -40 ... 257°F +/- 0.9°F
Humidity detection range	0 ... 100% r. H. +/- 2%, (non condensing)
CO2 detection range	0 ... 40.000ppm
Calibrated CO2 detection range	400 ... 2.000ppm (+/- 50ppm, + 5% of reading)
Ambient temperature	-20 ... 70°C / -4 ... 158°F
Humidity	max. 95% r.H. (non condensing)
Degree of Protection	IP30
Recommended mounting height	135cm / 53.15"

Connection terminals

Terminal type	DG220B
Wire cross-section	0.28 ... 0.8mm ² / AWG23 ... 18
Stripping length	5 ... 6mm / 0.2 ... 0.24"
Temperature resistance	-40 ... 105°C / -40 ... 221°F

Connection Diagram

Product Characteristics

Colours	White: RAL9003 - Part No. 100517 Anthracite: RAL7021 - Part No. 100518
Finish	Matte

Weight & Dimensions

Net weight	110g
Total weight	136g
Product dimensions	90x90x16mm / 3.55x3.55x0.63" (LxWxH)

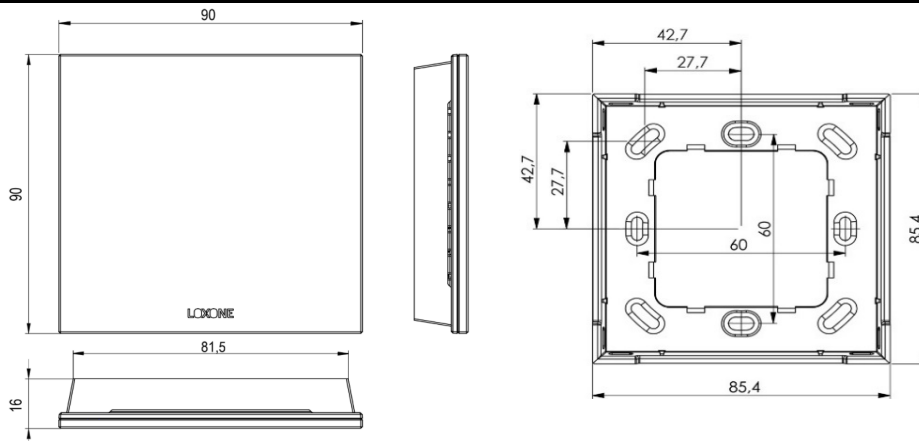

Pack size	104x107x39mm / 4.09x4.21x1.54" (LxWxH)
-----------	--

Certifications & Standards

Certifications



Installation must be carried out by a qualified electrician in accordance with the relevant regulations.

Published by
Loxone Electronics GmbH
Smart Home 1
4154 Kollerschlag
Austria
Tel: +43 7287 7070-0
loxone.com

Loxone UK
The Forum
Station Road
Theale, RG7 4RA
United Kingdom

Datenblatt

Touch Pure CO2 Tree

Art. Nr. 100517, 100518



Information zum Produkt

Der Loxone Touch Pure CO2 Tree verfügt über fünf Tastpunkte auf einer Glasfront, zur Bedienung der wichtigsten Funktionen eines Raumes. Bei Berührung einer Taste erfolgt ein Klicken als akustische Bestätigung. Zur Messung von Temperatur, relativer Luftfeuchte und CO2 Wert ist ein Sensor integriert. Ein Orientierungslicht ermöglicht das Erkennen des Gerätes im Dunkeln.

Technische Daten

Spannungsversorgung	6 ... 30VDC
Leistungsaufnahme	typ. 0,05W, max. 0,1W
Leistungsverlust	max. 0,1W
Schnittstelle	Loxone Tree: Verbindung mit Miniserver / Tree Extension
Tastpunkte	5 Tastpunkte, kapazitive Berührungserkennung
Klick Feedback	Ja
Orientierungslicht	Ja
Messbereich Temperatursensor	-40 ... 125°C +/- 0,5°C -40 ... 257°F +/- 0,9°F
Messbereich Luftfeuchtigkeitssensor	0 ... 100% r. H. +/- 2%, (nicht kondensierend)
CO2 Erfassungsbereich	0 ... 40.000ppm
Kalibrierter CO2 Messbereich	400 ... 2.000ppm (+/- 50ppm, + 5% des Messwerts)
Umgebungstemperatur	-20 ... 70°C / -4 ... 158°F
Luftfeuchtigkeit	max. 95% r.H. (nicht kondensierend)
Schutzart	IP30
Empfohlene Montagehöhe	135cm / 53,15"

Anschlussklemmen

Klemmentyp	DG220B
Leiterquerschnitt	0,28 ... 0,8mm ² / AWG23 ... 18
Abisolierlänge	5 ... 6mm / 0,2 ... 0,24"
Temperaturbeständigkeit	-40 ... 105°C / -40 ... 221°F

Anschlussplan

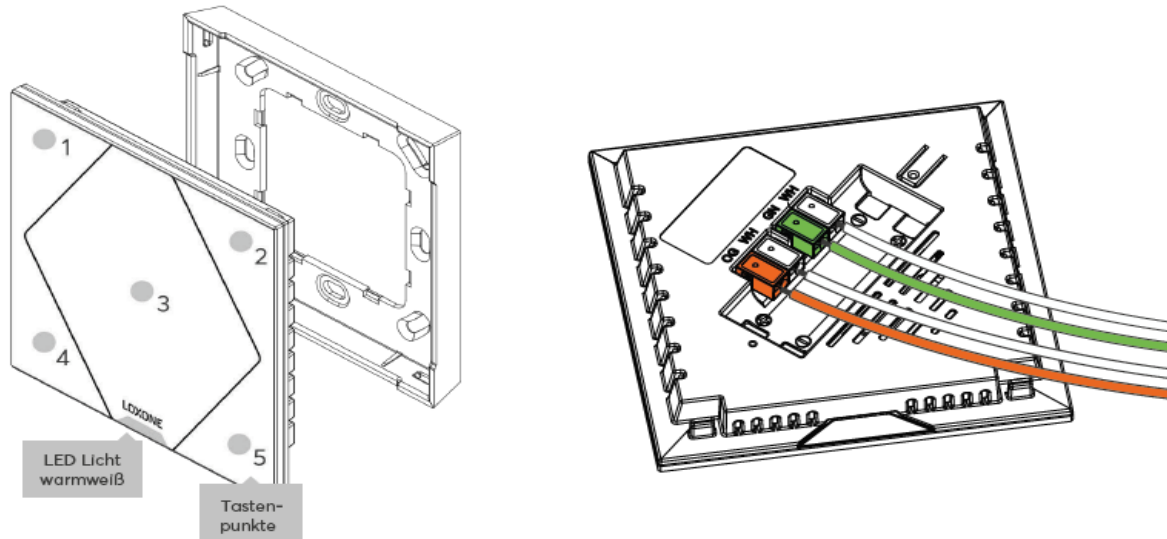

Produkteigenschaften

Farbe	Weiß: RAL9003 - Art. Nr. 100517 Anthrazit: RAL7021 - Art. Nr. 100518
Glanzgrad	Matt

Gewicht & Abmessungen

Nettogewicht	110g
Bruttogewicht	136g
Produktmaße	90x90x16mm / 3,55x3,55x0,63" (LxBxH)

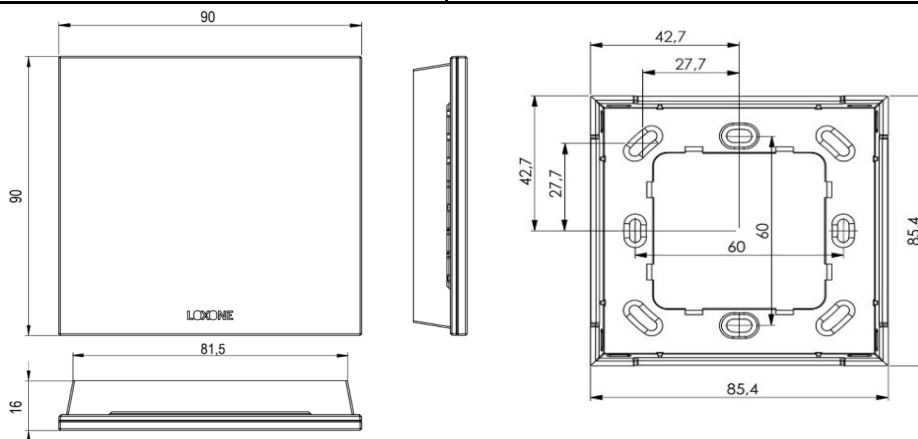

Packmaß	104x107x39mm / 4,09x4,21x1,54" (LxBxH)
---------	--

Zertifizierungen & Standards

Zertifizierungen



Die Installation muss nach den einschlägigen Vorschriften durch eine Elektrofachkraft erfolgen.

Veröffentlicht von
Loxone Electronics GmbH
Smart Home 1
4154 Kollerschlag
Austria
Tel: +43 7287 7070-0
loxone.com

Loxone UK
The Forum
Station Road
Theale, RG7 4RA
United Kingdom